

CL5200 SERIES | Anyshop Scale

TOTAL WEIGHING SOLUTION™

SPECIFICATIONS

Model	CL5200		
Max.capacity(kg)	3/6	6/15	15/30
Readability(g)	1/2	2/5	5/10
External resolution	1/3,000(dual interval)		
Display type	Graphic LCD(208 x 48)		
Printing speed	Max. 100 mm/sec		
Printer resolution	202 dpi		
Label size (mm)	Width:40~60, Length:30~120		
Power	AC 100~240V, 50/60 Hz		
Operating temperature	-10°C ~ +40°C		
Platter size (mm)	B,P Type:380(W) x 250(D)		
Dimensions(mm)	B Type:409(W) x 441(D) x 180(H) P Type:410(W) x 500(D) x 535.8(H)		
Product weight(kg)	B Type:6.95, P Type:7.65		

FEATURES

- Memory capacity: 10,000 PLUs & 1,000 ingredients
- Supporting free label format design
- Cartridge-loading-type label installation
- 45 fixed format & 20 customized format design
- Various interface
- Combined wide LCD display

OPTION

- Wireless bridge card
- PC manager program(CL-Works)
- Platter with back rail

DIMENSIONS

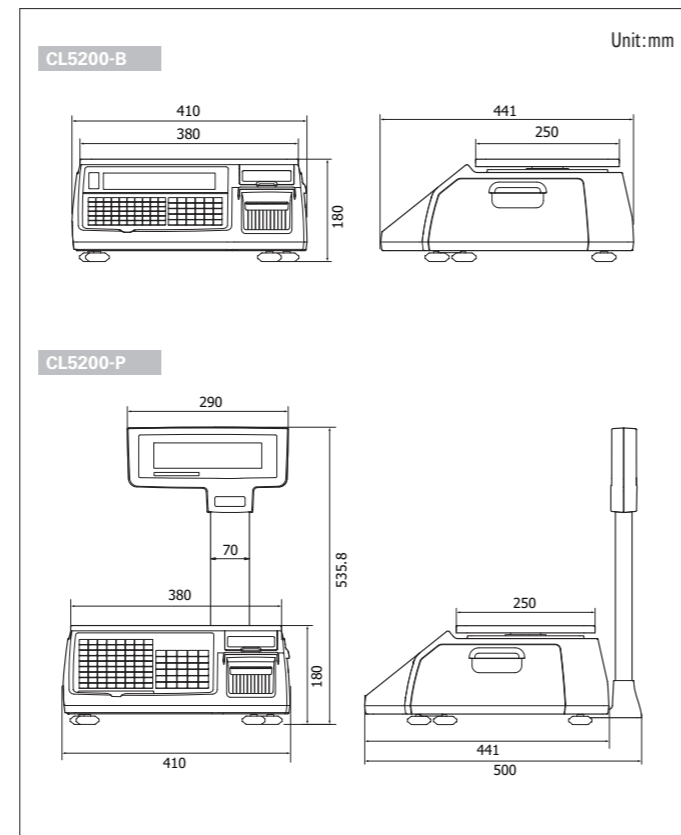

RETAIL WEIGHING SOLUTION™



Large LCD display



Easy loading Paper Cartridge



Direct PLU keys & function keys

CL5200 SERIES

It's a must-have scale for your shop!!

- Flexible & reliable network system (wired/wireless)
- Easy loading paper cartridge
- Free format label design
- User friendly PC software



CAS

CAS

CAS BLDG., # 440-1, SUNGNAE-DONG,
GANGDONG-GU, SEOUL, KOREA

TEL_ 82 2 2225 3500

FAX_ 82 2 475 4668

<http://www.globalcas.com>

Specifications are subject to change for improvement without prior notice.

CL5200 SERIES

TOTAL WEIGHING SOLUTION™

Hardware

Steady PLU keys

The embossing membrane keypad adds a steady look of CL5200-P and CL5200-B. Double-click function provides easy access to the key's secondary PLU, totaling in double of PLU key numbers.



Large display

Large full graphic LCD display is suitable for any environment. (208x48 dot graphic LCD).
- Tare/Weigh/Unit/Price : 4/5/6/6 digits



High speed printer

High speed thermal printer supports label/ticket printing. Guaranteed satisfaction with 100mm/s speed and 202dpi resolution.



Paper cartridge

Cartridge loading type supports quick and easy replacement of new label roll.
- Various paper support
- Auto measuring system

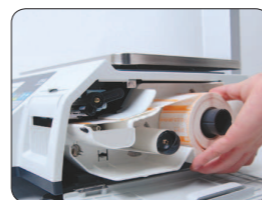

Various interface connetions

It supports RS-232c, PS/2, Cash drawer, wired/wireless Ethernet, and USB Device.

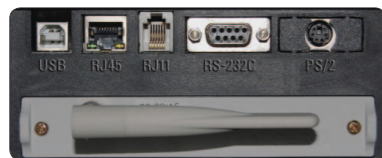

Menu system

No need to scroll through menus for programming settings. Unique 4 digit 'Menu Code' entry pin helps pinpoint the desired program field.
ex) Menu code '1120' is for editing PLU name.

PRODUCT LINE UP

- CL5200 is compatible with all CAS label printing scales in the same network
- Combined wide LCD looks better

CL5500 LINE UP



▶ CL5500-B



▶ CL5500-P



▶ CL5500-R



▶ CL5500-H



▶ CL5500-S



CL5200-B



CL5200-P

Software

Label Formats

There are 45 preset labels installed in the scale and additional 20 formats can be modified freely with CL-Works PC program.

- Continuous label/ticket
- Up to 120mm label length

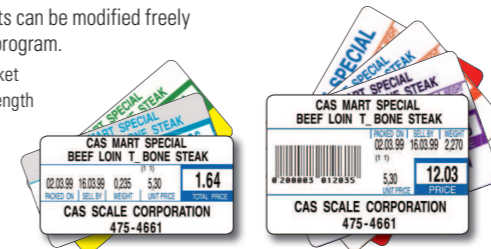

Barcode

Almost every conventional 1-Dimensional barcode types are available.

- UPC, EAN13, EAN13A5, I20F5, CODE128, CODE39, CODE93, CODABAR, IATA20F5



Network System

- TCP/IP communication protocol
- IEEE802.11g specification wireless network
- Wireless security : WEP 64/128, WPA, WPA2
- One to one & multi to multi & wired/wireless network
- Network structure for
 - Large, medium and small independent markets
 - Pre-pack and self-service counter
 - Hyper market

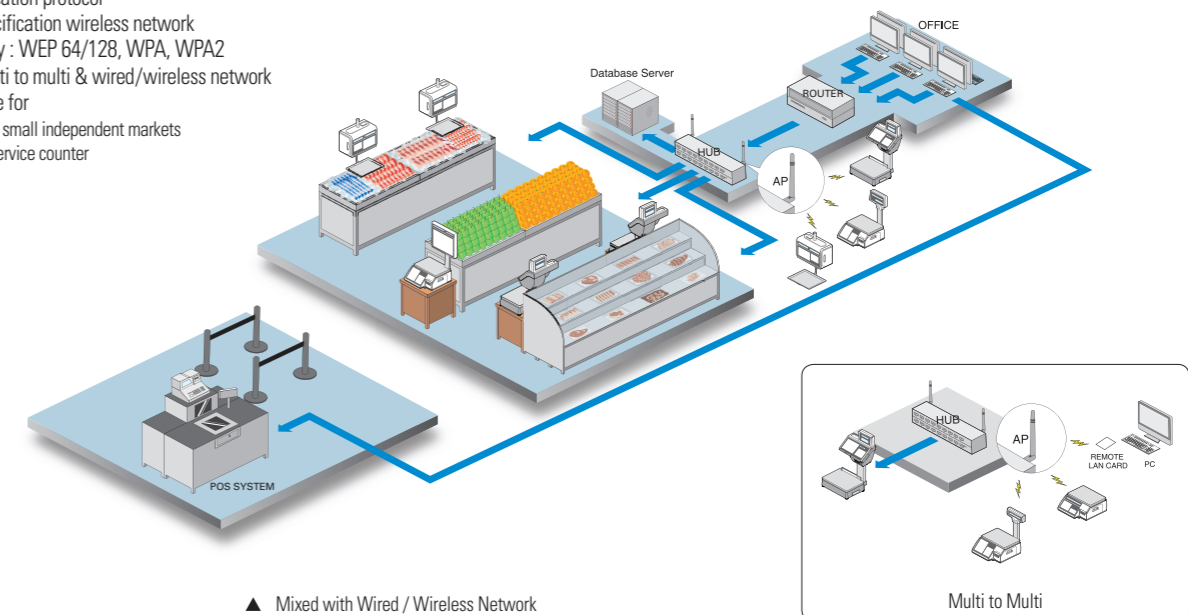

PC software:CL-Works

CL5200 supports PLU programming, store data, sales report, label editor and much more.

You can control all the program data by CL-Works. CL5000, CL5000J and CL5500 share this software with CL5200.

CL-Works

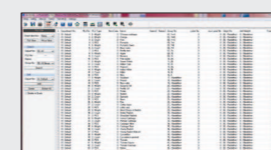

PLU Editor

- Enable easy control, of PLU
- Allows PLUs management by excel

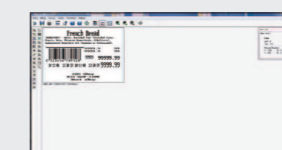

Label Editor

- 20 modifiable label formats
- Easy downloading of label formats

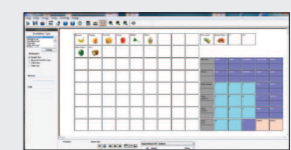

Keypad Editor

- Easy to setup and download
- Key design color image
- Keypad supported